

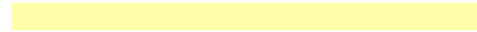

DAB PUMPS S. p. A.
Via Marco Polo, 14 - 35035 Mestrino (PD) - ITALY
Tel. +39 049 5125000 - Fax +39 049 5125950
[Http://www.dabpumps.com](http://www.dabpumps.com)

-
Phone



-
To the attention of

Sent:

Subject:

Sincerely,

Phone
Cell.



QUOTATION

DAB PUMPS S.p.A.
 Via Marco Polo, 14 - 35035 Mestrino (PD), Italy
 Tel. +39 049 5125000 - Fax +39 049 5125950
 www.dabpumps.com

2021-05-1€

Page 2 / 7

	Receiver	From
Society Reference Address Phone Fax E-mail		

Pos.no	Item no.	Description	Quant.	UP / AUD	TP / AUD
1		ESYBOX MAX my20 (Q= H=)			
1.1		Centrifugal pump: 1 ESYBOX MAX 85/120 T 1 ESYBOX MAX 85/120 T TECHNICAL DATA Flow rate: Up to 17,4 m3/h (For single unit) Head: 113 m Type of pumped liquid: Clean, free from solid or abrasive substances, non-viscous, non-aggressive, non-crystallized and chemically neutral Liquid temperature: +50°C Maximum ambient temperature: +55°C Maximum inlet pressure: 5 bar Operation pressure: 12 bar / 1200 kPa Constant pressure range: 1-12 bar (3 bar by default) Motor protection class: IP X5 Motor insulation class: F Impeller material: Technopolymer Single phase power input: 208-240V 50/60Hz Three phase power input: 380-480V 50/60Hz Type of installation: Fixed in vertical position Certification: NSF61. WRAS and ACS are pending approval. Integrated pumping system for pressurization in commercial building service. Available in two power sizes, it consists of modular elements that allow different configurations to cover the needs of medium/large condominiums and high buildings (even over 14 floors). Each unit consists of the single, double or triple connection base and the pumping units; a four-pumps system is available with the additional kit to connect two double bases. The modular construction allows to assemble the pumping groups directly at the installation site (O.S.A. concept). The silence and compactness of dimensions allow installation in all rooms, even inhabited. CONSTRUCTION FEATURES OF THE PUMP Electronic vertical multi-impeller pump, with display, pressure sensors on intake and delivery, non-return valve on delivery and an integrated expansion tank. Pump body and impellers in technopolymer with steel jacket. CONSTRUCTION FEATURES OF THE MOTOR Water-cooled permanent magnet motor, stainless steel motor jacket. Motor shaft in AISI 303 stainless steel. CONSTRUCTION FEATURES OF THE ELECTRONIC The variable frequency drive keeps the pressure constant by varying the number of motor revolutions according to the request. There is a large display for the configuration and control. The expansion module (esy I/O, available as an accessory) makes it possible to interface Esybox Max with the other elements of the system (BMS). Integrated protections: protection from dry running, amperometric and abnormal voltages, overheating, freezing, anti-blocking and anti-cycling. DCONNECT It is possible to configure and view the operating parameters on the large Esybox Max display or thanks to the DConnect app and the integrated Wi-Fi module, it is possible to do it remotely with an active DConnect service (an Internet connection is required). From a smartphone or a tablet it is possible to control and manage system pressure, alarms and check the instantaneous and historical consumption. With DSynC technology, the user experience of Esybox Max is simplified. Using their smartphone or tablet, the installer interfaces with the pump that automatically detects the language, the time and the unit of measurement used in the Country of installation. In the case of a booster set, once the installation of the first pump is completed, the Esybox Max automatically synchronize the other pumps. The DSynC also allows you to connect the pump to the outside world, through the Modbus protocol.	1	0,00	0,00

MAIN_PROJECT_TITLE	BUSINESS_PROCESS_IT	OWNER_	ISSUE_DATE 2021-05-18	LAST_MODI_DATE 2021-05-18
--------------------	---------------------	--------	--------------------------	------------------------------



WATER • TECHNOLOGY

QUOTATION

2021-05-18

Page 3 / 7

DAB PUMPS S.p.A.
Via Marco Polo, 14 - 35035 Mestrino (PD), Italy
Tel. +39 049 5125000 - Fax +39 049 5125950
www.dabpumps.com

Receiver

From

Society
Reference
Address
Phone
Fax
E-mail

Pos.no	Item no.	Description	Quant.	UP / AUD	TP / AUD
1.2		1 Esybox Max 85/120 T			
1.2.1	60195100	ESYBOX MAX 85/120 T 380-480 PUMP	1	Price on req.	Price on req.
1.2.2	60195200	ESYDOCK MAX GAS	1	Price on req.	Price on req.

Total Price on req.

MAIN_PROJECT_TITLE

BUSINESS_PROCESS_IT

OWNER_

ISSUE_DATE

LAST_MODI_DATE

2021-05-18

2021-05-18

Receiver

From

Society
Reference
Address
Phone
Fax
E-mail

Item n° :

Model :

1 ESYBOX MAX 85/120 T

Pump data

Pressure rating : 12 bar (1200 KPa)
Constant pressure range: 1-12 bar (3 bar by default)
Min. fluid temperature : 0 °C
Max. fluid temperature : 50 °C
Max. Ambient temperature : 55 °C

Requested data

Flow :
Head :
Fluid : Water
Fluid Temperature : 20 °C
Density : 998,3 kg/m³
Kinematic viscosity : 1,005 mm²/s
Vapor pressure : 2,34 kPa

Materials

Fitting	Technopolymer PA66 30%GF
Manifold	Stainless Steel AISI 304
Flange	Technopolymer PA66 30%GF
Pump body	Technopolymer PA66 30%GF
Pump body ring	Technopolymer PP 30%GF
Impeller	Technopolymer PP 30%GF/AISI 304
Diffuser	Technopolymer PP 30%GF/AISI 304
Motor axis	Stainless Steel AISI 303
OR ring	EPDM
Motor flange	Technopolymer PA66 30%GF
Mechanical seal	Graphite/Stainless Steel/EPDM
Motor liner	Stainless Steel AISI 304
Motor body	Technopolymer PA66 30%GF
Conveyor tube	Technopolymer PP 30%GF
Pressure sensor	Nylon/EPDM
Non-return valve	POM/EPDM/AISI 302
Non-return valve body	Technopolymer PA66 30%GF
Tank	Noryl/Rubber
Delivery body	Technopolymer PA66 30%GF
Outer liner	Stainless Steel AISI 304

Curve tolerance according to ISO 9906

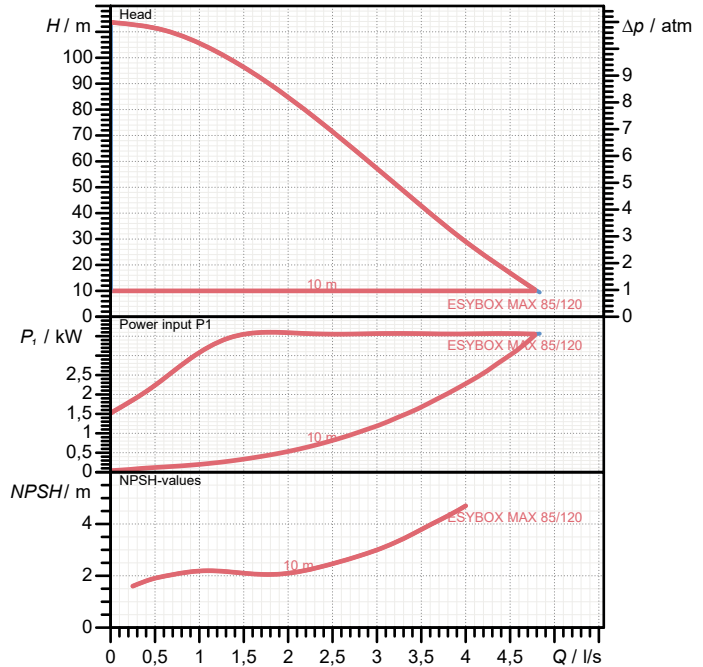

Hydraulic data (duty point)

Flow :
Head :

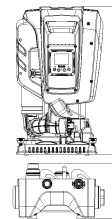
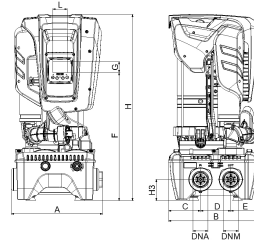

Dimensions in mm

A	375	E	127,7	H3	87		
B	384	F	526	L	59,5		
C	131,8	G	45				
D	124,5	H	766				
DNA	1"1/4 - :	H1	613				
DNM	1"1/4 - :	H2	228				

Weight : 39 kg

Pump connection

Suction side : 1"1/4 - 2" G / 12 bar (1200 KPa)
Discharge side : 1"1/4 - 2" G / 12 bar (1200 KPa)

Motor data

Power input P1 : 1 x 3,5 kW
Rated speed : 5.350 1/min
Rated voltage : 3~ 380-460 V 50 Hz
Nominal current : 1 x 5,5 A
Degree of protection : IP X5

ENERGY SAVING

BEFORE

AFTER

- **20%**
Compared with
traditional inverter pump

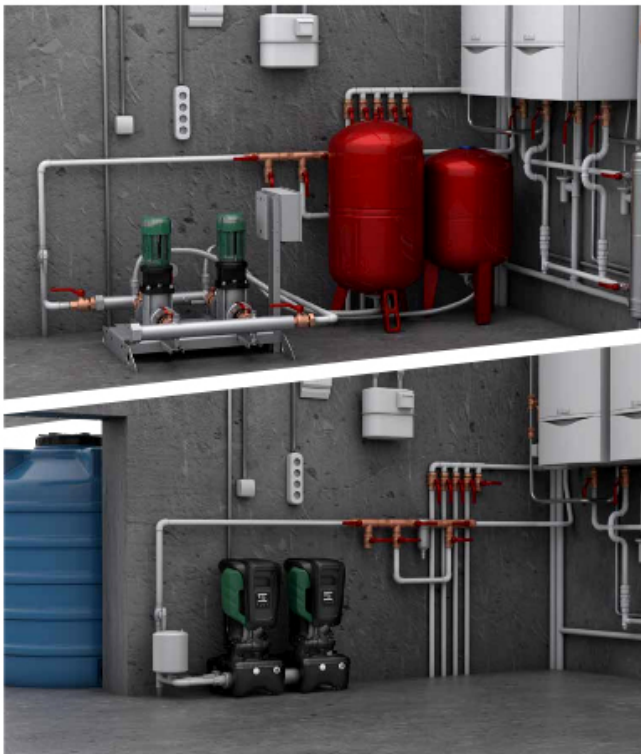

D+CONNECT
BUILT-IN



As quick as a "click"





WATER • TECHNOLOGY

PERFORMANCE CURVES

2021-05-1€

Page 6 / 7

DAB PUMPS S.p.A.
Via Marco Polo, 14 - 35035 Mestrino (PD), Italy
Tel. +39 049 5125000 - Fax +39 049 5125950
www.dabpumps.com

Receiver

From

Society
Reference
Address
Phone
Fax
E-mail

1 ESYBOX MAX 85/120 T

Curve tolerance according to ISO 9906

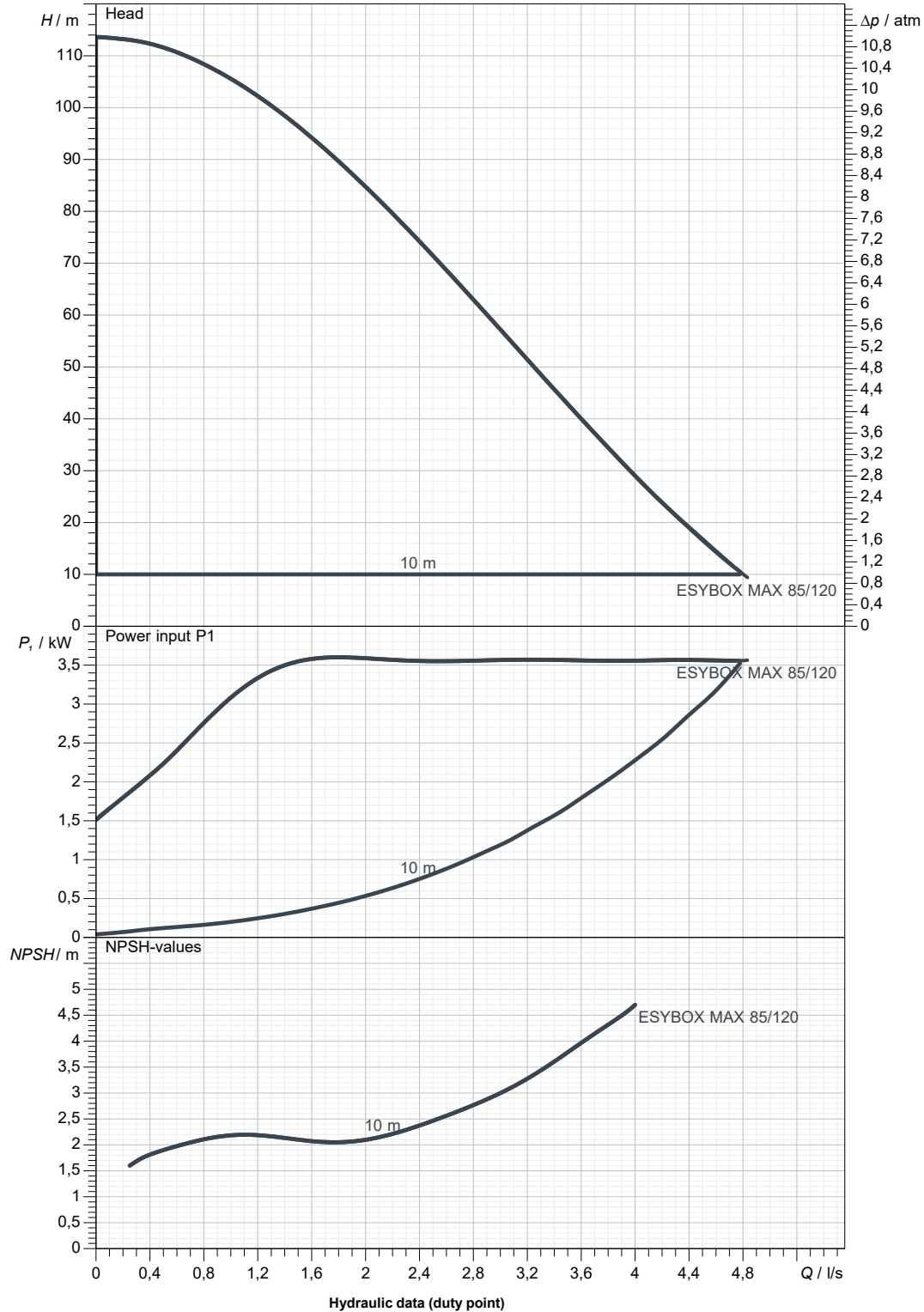

Suction side :
1"1/4 - 2" G
12 bar (1200 KPa)

Discharge side :
1"1/4 - 2" G
12 bar (1200 KPa)

Flow :

Head :

Rated speed :
5.350 1/min

MAIN_PROJECT_TITLE

BUSINESS_PROCESS_ID

OWNER_

ISSUE_DATE
2021-05-18



DIMENSIONAL DRAWING

2021-05-18

Page 7 / 7

DAB PUMPS S.p.A.
Via Marco Polo, 14 - 35035 Mestrino (PD), Italy
Tel. +39 049 5125000 - Fax +39 049 5125950
www.dabpumps.com

Receiver

From

Society
Reference
Address
Phone
Fax
E-mail

1 ESYBOX MAX 85/120 T

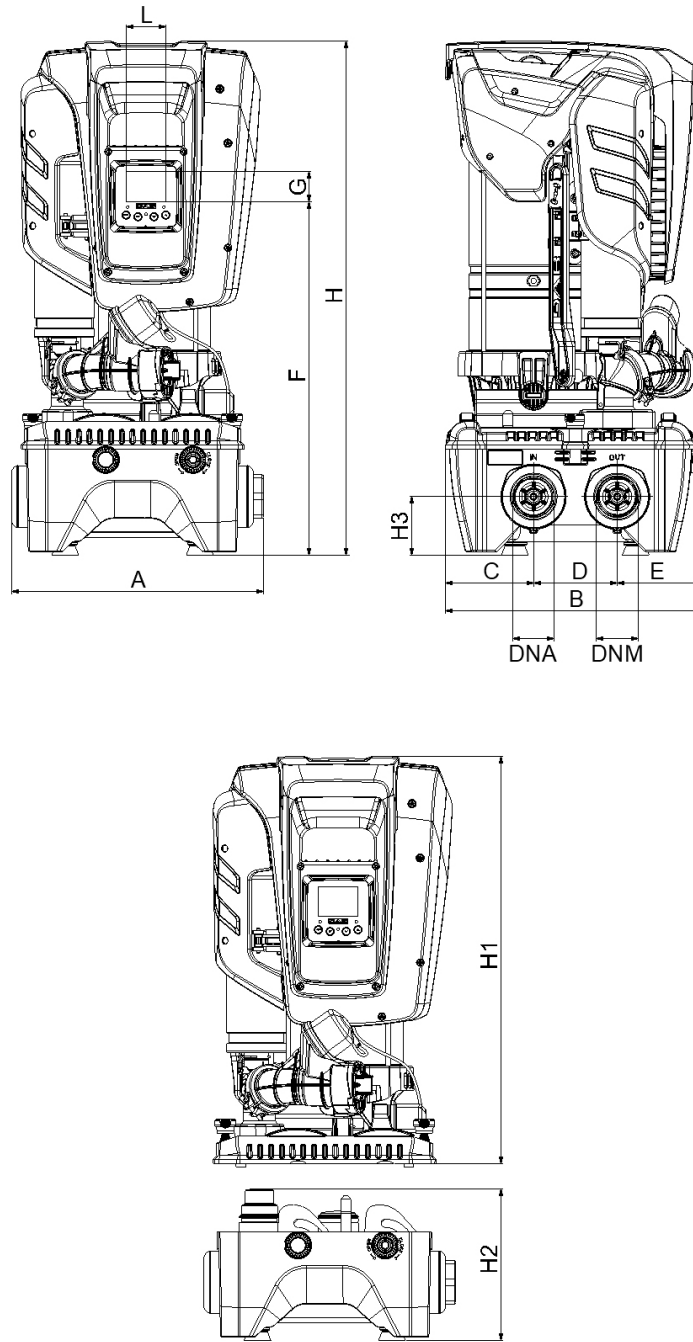

Dimensions in mm

Pump connection

1	A	375	H3	87			
2	B	384	L	59,5			
3	C	131,8					Suction
4	D	124,5					1"1/4 - 2" G
5	DNA	1"1/4 - 2"					12 bar (1200 KPa)
6	DNM	1"1/4 - 2"					
7	E	127,7					Discharge
8	F	526					1"1/4 - 2" G
9	G	45					12 bar (1200 KPa)
10	H	766					
11	H1	613					
12	H2	228					

MAIN_PROJECT_TITLE

BUSINESS_PROCESS_ID

OWNER

ISSUE_DATE

2021-05-18